

Features

- 1.6mmX0.8mm SMT LED, 1.1mm THICKNESS.
- MECHANICALLY AND SPECTRALLY MATCHED TO THE PHOTOTRANSISTOR.
- WATER CLEAR LENS.
- PACKAGE: 2000PCS / REEL.
- MOISTURE SENSITIVITY LEVEL : LEVEL 3.
- RoHS COMPLIANT.



Notes:

1. All dimensions are in millimeters (inches).
2. Tolerance is $\pm 0.1(0.004)$ " unless otherwise noted.
3. Specifications are subject to change without notice.

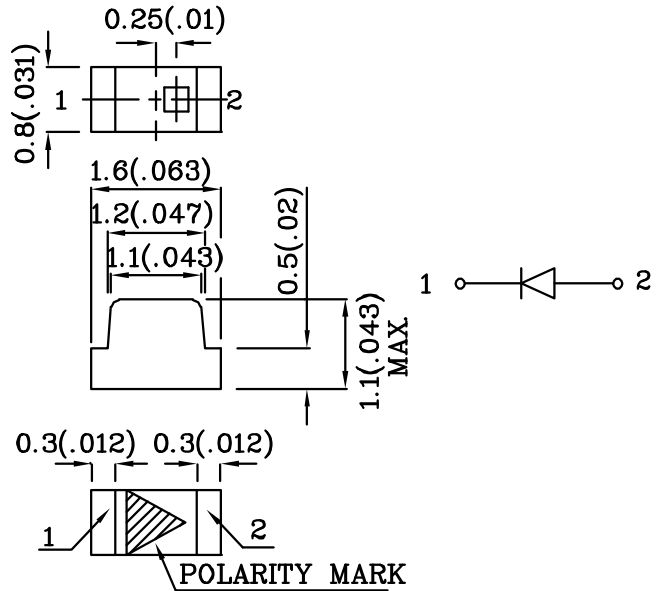

Absolute Maximum Ratings (TA=25°C)		THI (GaAlAs)	Unit
Reverse Voltage	VR	5	V
Forward Current	IF	50	mA
Forward Current (Peak) 1/100 Duty Cycle 10us Pulse Width	iFS	1.2	A
Power Dissipation	PT	80	mW
Operating Temperature	TA	-40 ~ +85	°C
Storage Temperature	Tstg	-40 ~ +85	

Operating Characteristics (TA=25°C)		THI (GaAlAs)	Unit
Forward Voltage (Typ.) (IF=20mA)	VF	1.3	V
Forward Voltage (Max.) (IF=20mA)	VF	1.6	V
Reverse Current (Max.) (VR=5V)	IR	10	uA
Wavelength of Peak Emission (Typ.) (IF=20mA)	λP	880	nm
Spectral Line Full Width At Half-Maximum (Typ.) (IF=20mA)	$\Delta\lambda$	50	nm
Capacitance (Typ.) (VF=0V, f=1MHz)	C	90	pF

Part Number	Emitting Color	Emitting Material	Luminous Intensity (Po=Mw/sr) @20mA		Wavelength nm λP	Viewing Angle 2 θ 1/2
			min.	typ.		
ZTHI53W	GaAlAs	Water Clear	0.4	0.8	880	120°
Published Date : FEB 28,2008 Drawing No : SDSA3659 V5 Checked : B.L.LIU P.1/4						

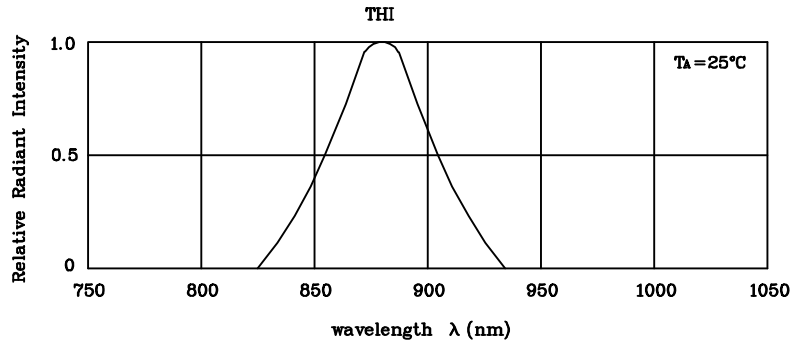

RELATIVE INTENSITY Vs. WAVELENGTH

❖ **THI**

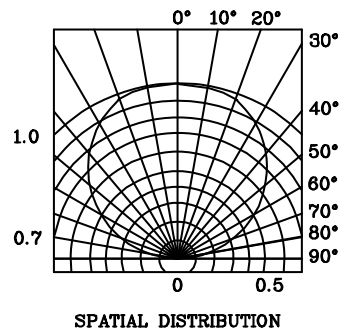
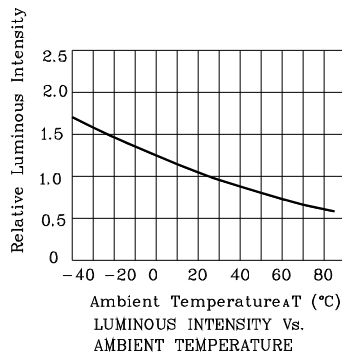
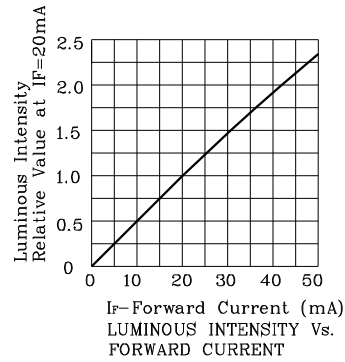
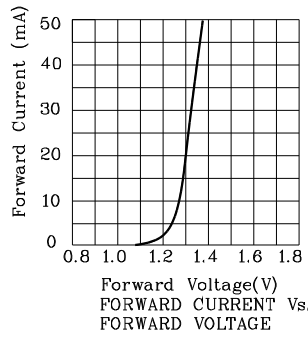

Reflow Soldering Profile For Lead-free SMT Process.

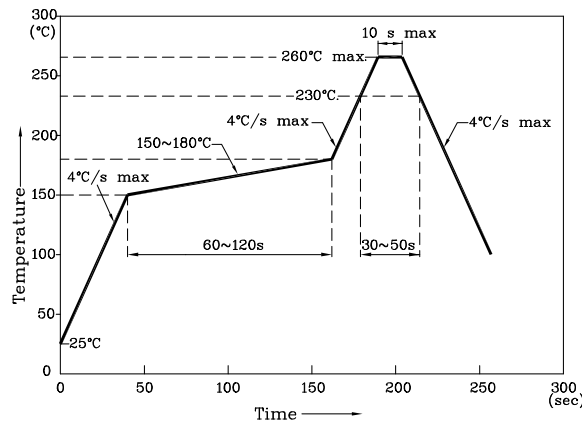

NOTES:

1. Maximum soldering temperature should not exceed 260°C.
2. Recommended reflow temperature: 145°C–260°C.
3. Do not put stress to the epoxy resin during high temperatures conditions.

❖ Recommended Soldering Pattern
(Units : mm; Tolerance: ± 0.1)

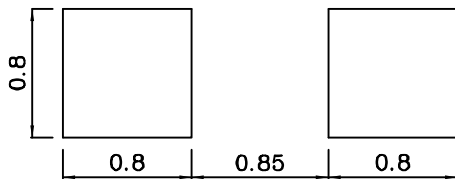

❖ The device has a single mounting surface. The device must be mounted according to the specifications.

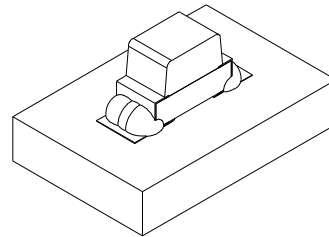

❖ Tape Specification (Units : mm)

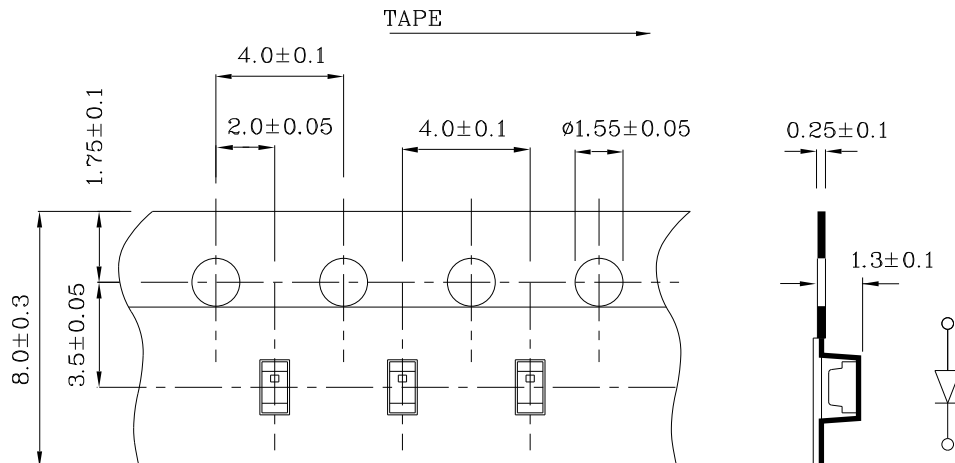

Remarks:

If special sorting is required (e.g. binning based on forward voltage or radiant intensity / luminous flux), the typical accuracy of the sorting process is as follows:

1. Radiant Intensity / Luminous Flux: +/-15%
2. Forward Voltage: +/-0.1V

Note: Accuracy may depend on the sorting parameters

PACKING & LABEL SPECIFICATIONS

ZTHI53W

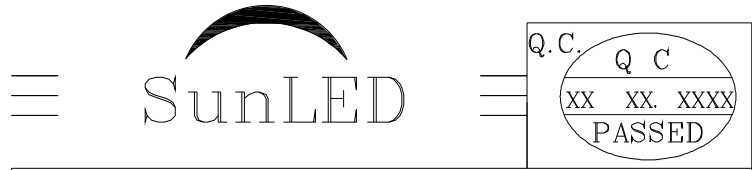
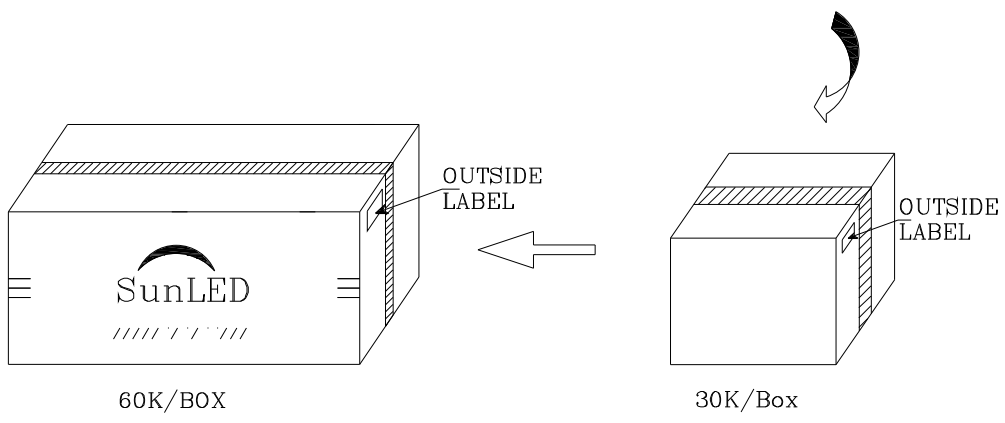
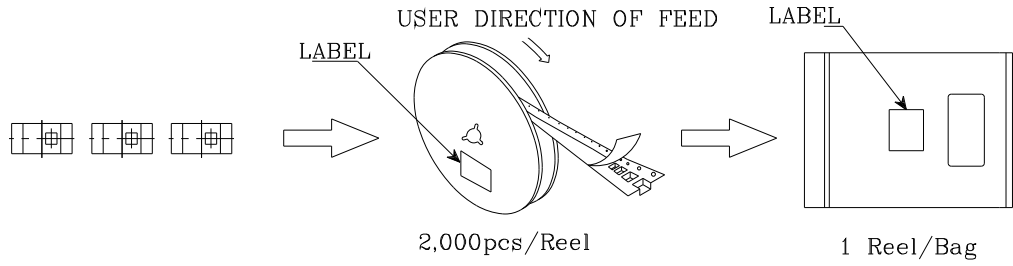

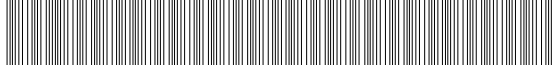
P/NO : Zxxx53x	
QTY : 2,000 pcs	CODE: XXX
S/N : XX	
LOT NO :	
 XXXXXXXXXXXXXXXXXXXXXXXXXXXX	
RoHS Compliant	